

Create an expression to determine the volume of each box.

Answers

1)

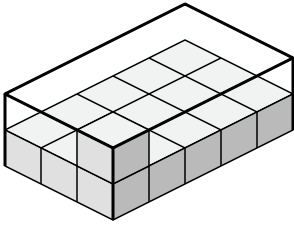

2)

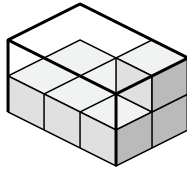

3)

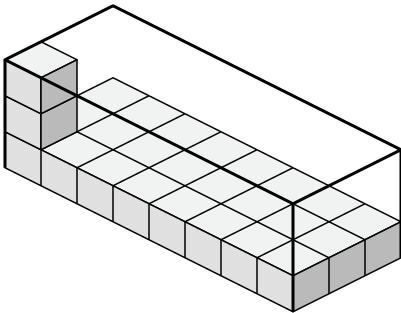

4)

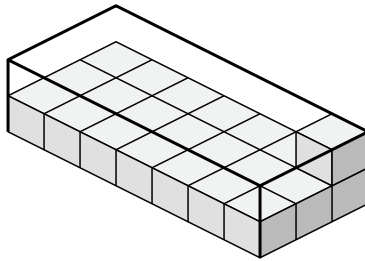

5)

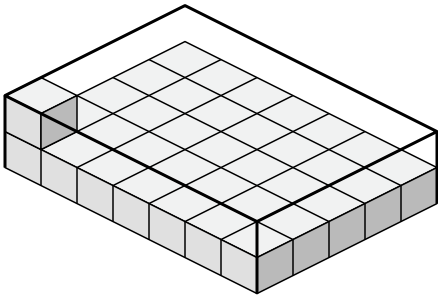

6)

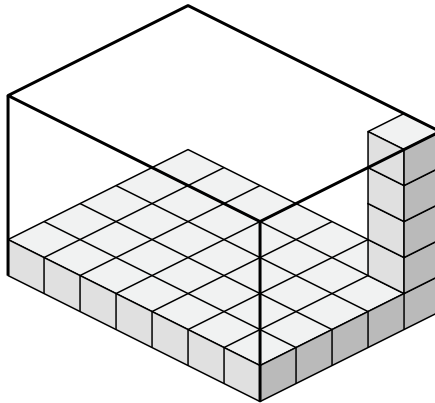

7)

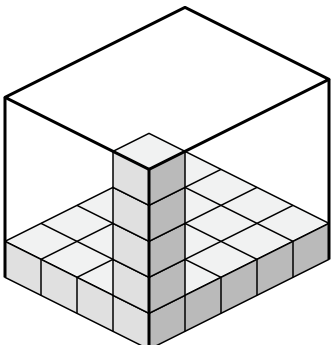

8)

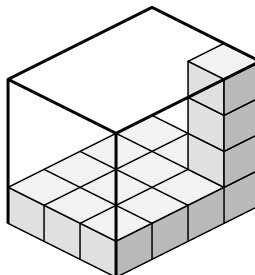

1. _____

2. _____

3. _____

4. _____

5. _____

6. _____

7. _____

8. _____



Create an expression to determine the volume of each box.

1)

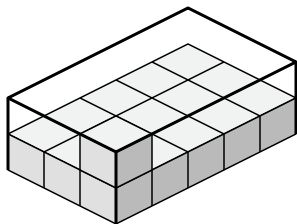

2)

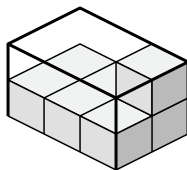

3)

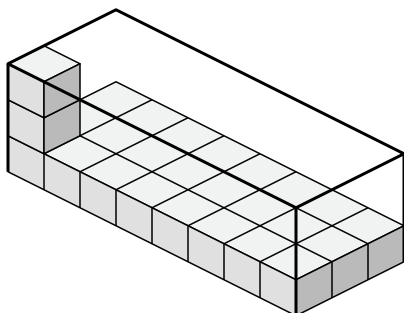

4)

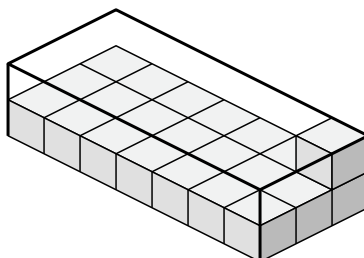

5)

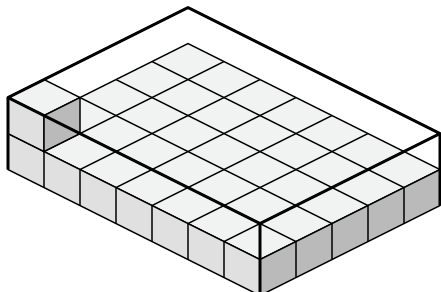

6)

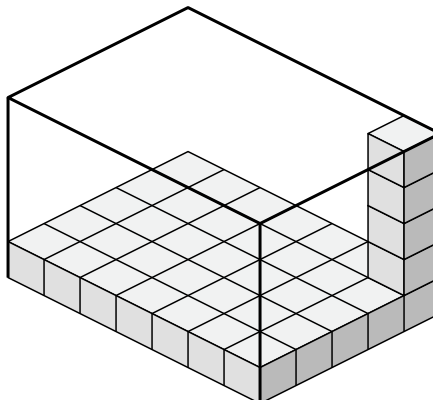

7)

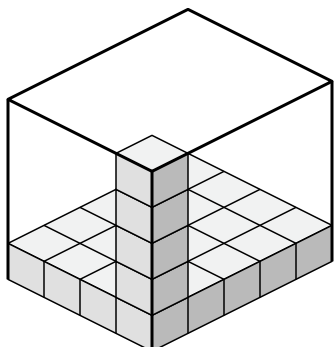

8)

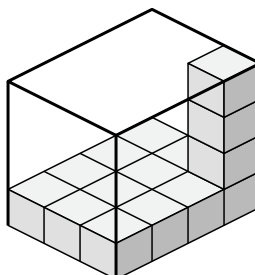

Answers

1. 3×5×2

2. 3×2×2

3. 8×3×3

4. 7×3×2

5. 7×5×2

6. 7×5×5

7. 4×5×5

8. 3×4×4